

D3 Lightscreen™ overview

PAGE 1



D3 Lightscreen

The D3 Display

A freestanding system that can combine ultra slim Lightscreen displays with leaflet dispensers, poster holders and product display shelves.

Designed to display smaller format graphics and to carry more weight, the D3 compliments the larger D4 banner display.

All components are lightweight and of the highest quality, making the displays both portable and durable. The system uses a minimum number of fixings and requires no tools or specialist knowledge for rapid self assembly.

The D3 display is perfect for reception areas, conference venues, marketing suites and exhibitions stands.

The system uses innovative LED technology. Only 6mm thick and with a low energy consumption, the Lightscreen is a state of the art lightbox. Your images are easy to insert and will have intense, vibrant colour.

Lightscreens come with 3m of cable and a standard three pin wall plug. Cables are housed inside the central mast. Lightscreens can be used on their own, or combined with dispensers, shelves and header boards to create a multi-functional D3 display.

Alternative display options:

	Narrow Cable Position			Wide Cable Position		
	A4	A3	A4 + Dispenser	A3 + Dispenser	A3	Header + A3 + Dispenser
Display Weight	6.6kg	7.2kg	7.3kg	8.3kg	7.6kg	8.2kg
Maximum Loading	—	—	1.1kg	2.2kg	1.1kg	1.1kg
Shipping Weight in travel bag	9.6kg	10.2kg	10.3kg	11.3kg	10.6kg	11.2kg

D3 Lightscreen™ specifications and options

PAGE 2



D3 Lightscreen

Height 165cm
Width 54cm
Depth 35cm
Weight 6.5kg – 8.2kg

D3 Lightscreen Sizes

Lightscreen panels are 6mm thick plus a 2mm cover sheet. Your back lit film graphic is sandwiched between the two sheets of acrylic. The front cover sheet has an opaque silver band which frames your image and is held in place with snap fit recessed magnets.

Available in A4, A3 and A2* sizes. The illuminated visual area of each screen is ISO 'A' size. e.g. Visual area of the A3 Lightscreen is 420mm x 297mm. We recommend adding 10mm bleed all round to your back lit film graphic eg: the graphic for this model would be 440mm x 317mm.

A4 and A3 sizes can be used in either landscape or portrait format. Lightscreens can only be used on standard 1.65m high D3 frames.

*A2 Lightscreens can only be used in portrait format, are only suitable for installation in certain types of environment and cannot be combined with leaflet dispensers or shelves.

Assembly:

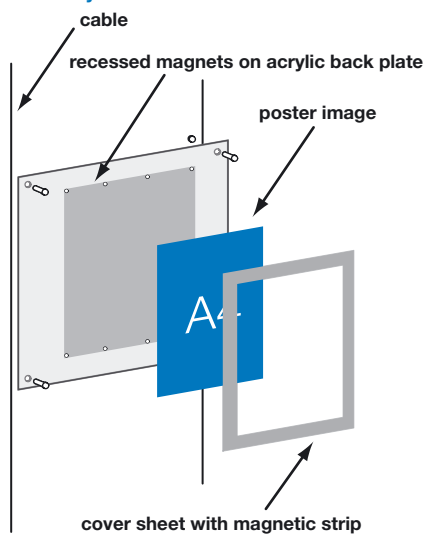

D3 Lightscreen Sizes:

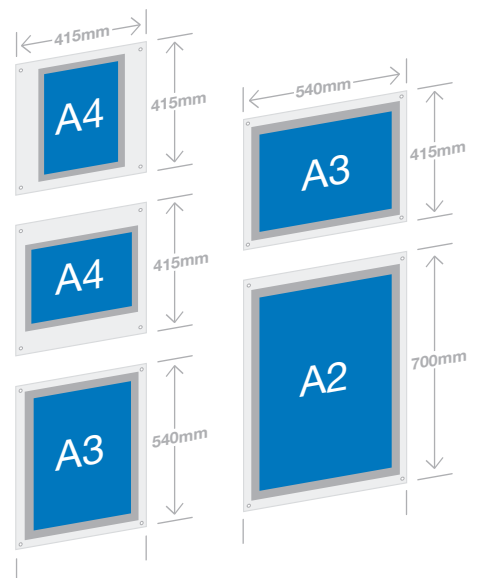

Accessories:

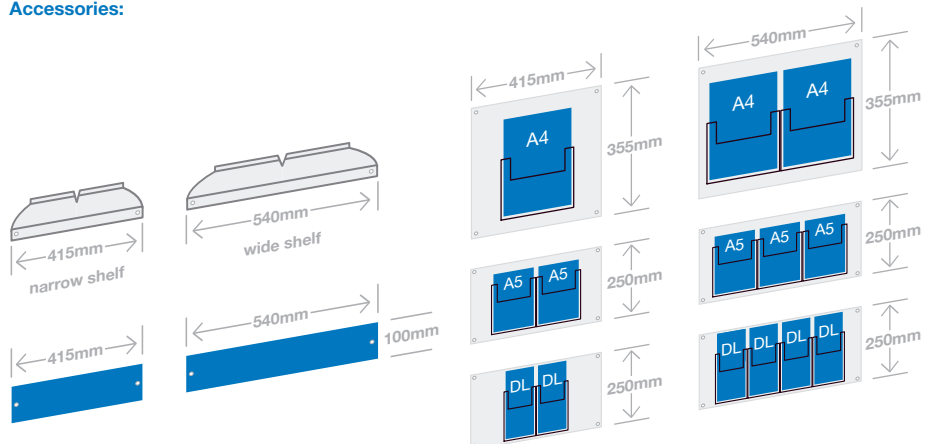

D3 Posters and Poster Holders overview



D3 Poster display with A4 dispensers

Height 180cm
Width 54cm
Depth 35cm
Weight 7kg – 10.3kg



A3 Landscape poster holder

D3 Poster Holder Sizes

Poster holders are available in ISO A4, A3 and A2 sizes. Posters are held in place between the 3mm clear acrylic back sheet and a 2mm cover sheet. The cover sheet has an opaque silver band which frames your image and is held in place with snap fit recessed magnets.

Alternatively, A1 and A2 poster banners can be printed directly onto a range of substrates. We recommend using 300 micron opal jet with seal for these posters. PVC support bars are then glued to the back of the poster, which is attached directly to the cables with our standard cable fixings.

Poster holders and banners can be displayed using either the standard 1.65m high frame or the taller 1.8m high frame.

	Narrow Cable Position					
	Poster Holders				Banner graphic	
165cm						
Display Weight	6.0kg	6.4kg	6.7kg	7.1kg	5.4kg	6.1kg
Maximum Loading	—	—	1.1kg	1.1kg	—	1.1kg
Shipping Weight in travel bag	9.0kg	9.4kg	9.7kg	10.3kg	6.9kg	7.6kg

	Wide Cable Position			
	Poster Holders		Banner graphic	
180cm				
Display Weight	7.2kg	8.2kg	5.6kg	6.6kg
Maximum Loading	—	2.2kg	—	2.2kg
Shipping Weight in travel bag	n/a	n/a	7.1kg	9.6kg

D3 Posters and Poster Holder options

PAGE 4



D3 Poster display with A4 dispensers

Height 180cm
Width 54cm
Depth 35cm
Weight 7kg – 10.3kg

Poster holder back panels are 3mm high impact clear acrylic with 2mm front covers. A1 and A2 poster graphics can be printed directly onto a choice of substrates, ready fixed with battens for attaching to the cables.

Assembly:

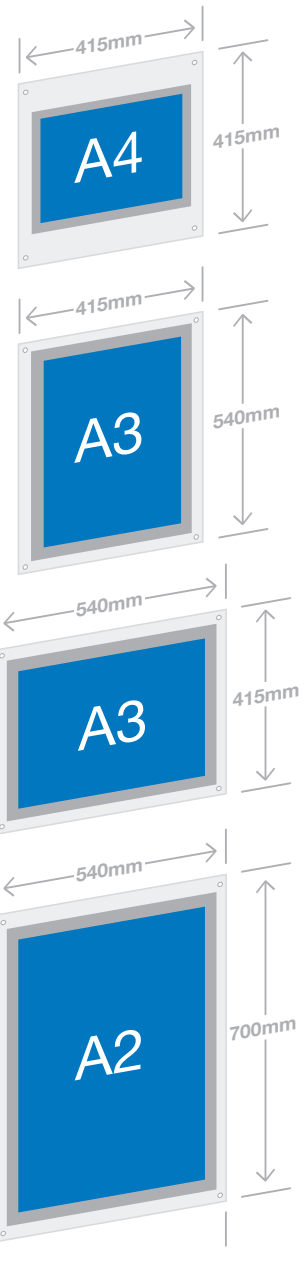
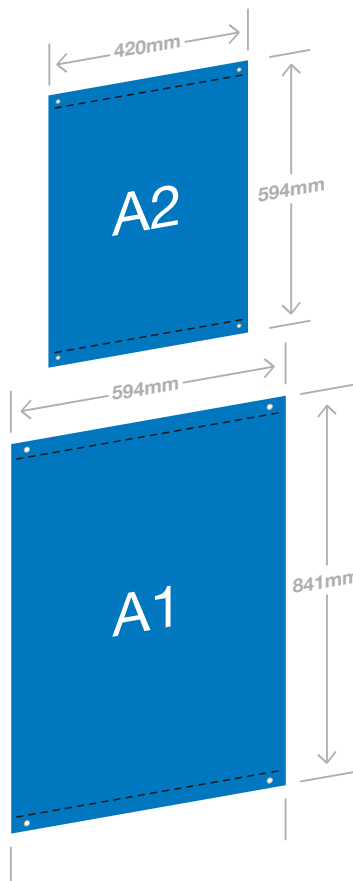
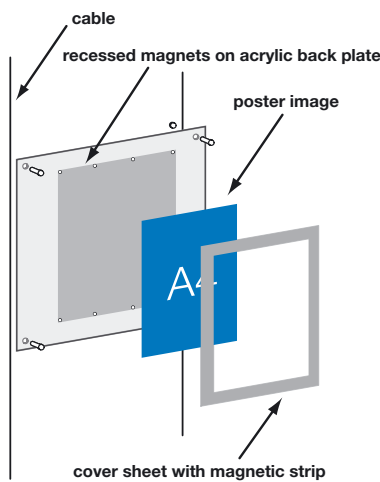

D3 Leaflet Dispensers overview

Easy to attach dispensers are made from hi-impact clear acrylic. All pockets are 20mm deep and come in a range of standard document sizes A4, A5 and DL.

The dispensers are available in two width options, narrow or wide, choose the one that best suits the size and amount of literature to be displayed.

Multiple rows of dispensers, up to a maximum of three can be attached to the standard 1.65m high D3 frame. There is the ability to mix and match different dispensers sizes on the same system and add product shelves and header boards as well to brand each display.

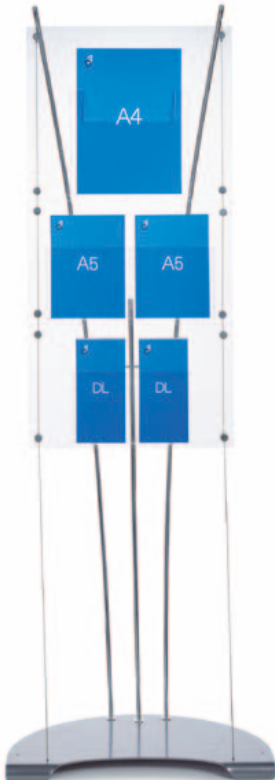

D3 Leaflet dispenser
A4 / A5 / DL capacity

Height 165cm
Width 54cm
Depth 35cm
Weight 9.5kg – 11.5kg



All components can be attached using our standard cable fixing

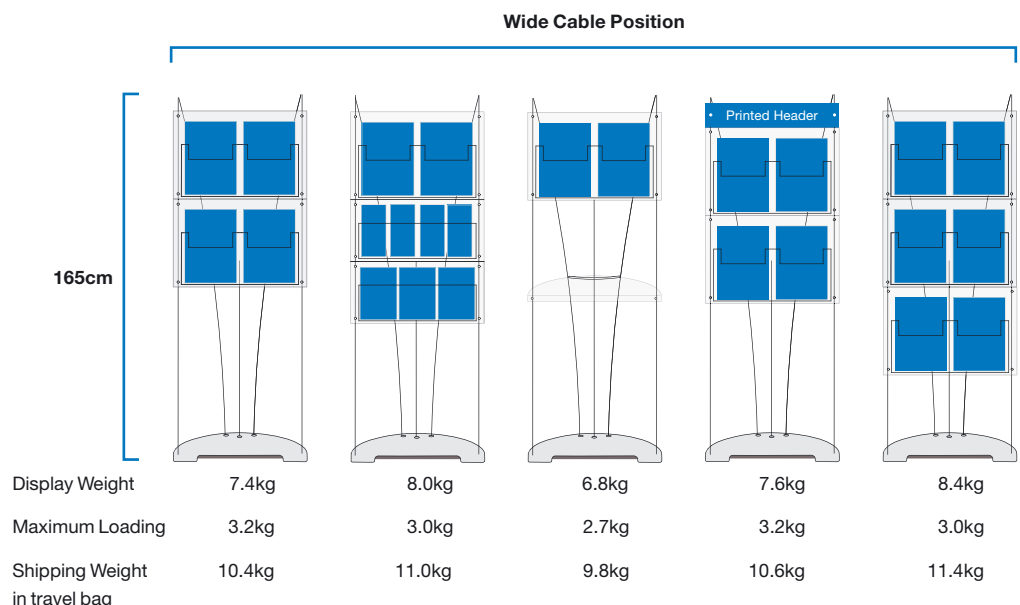
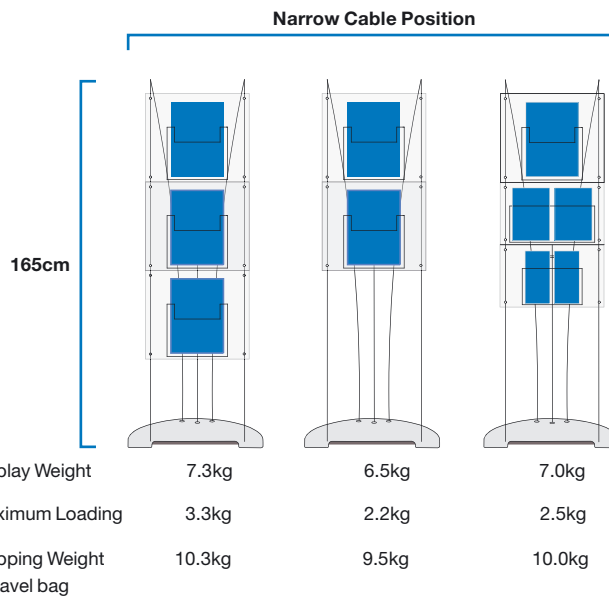

D3 Leaflet Dispensers options

PAGE 6

D3 Dispensers are made from 3mm high impact clear acrylic. Individual dispensers come with four hand tightening clamps for attaching to the tension cables.

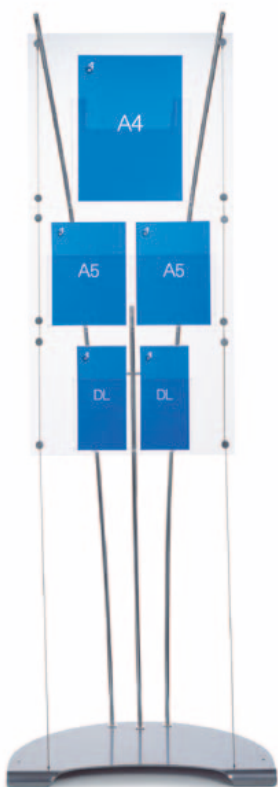

D3 Leaflet dispenser
A4 / A5 / DL capacity

Height 165cm
Width 54cm
Depth 35cm
Weight 9.5kg – 11.5kg

Single A4
Overall size 415 x 355mm
Pocket width 236mm

Double DL
Overall size 415 x 250mm
Pocket width 2 of 115.5mm

Double A5
Overall size 415 x 250mm
Pocket width 2 of 165.5mm

All pockets have a 20mm capacity

Double A4
Overall size 540 x 355mm
Pocket width 2 of 236mm

Quadruple DL
Overall size 540 x 250mm
Pocket width 2 of 115.5mm

Double A5
Overall size 540 x 250mm
Pocket width 2 of 165.5mm

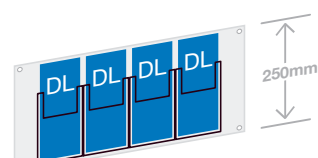
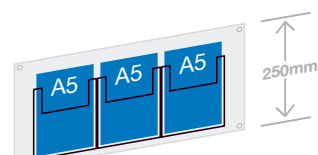
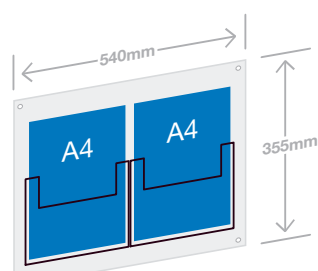
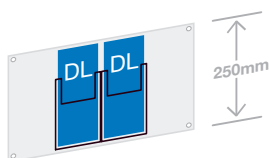
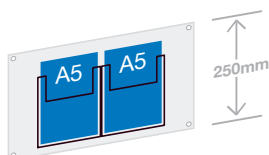
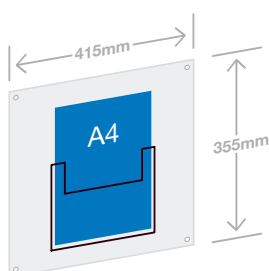

Accessories:

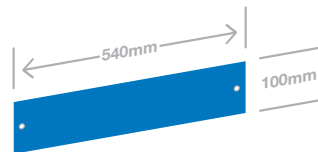
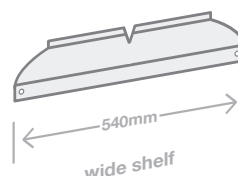
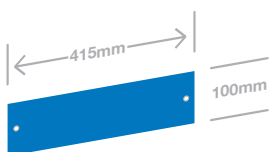
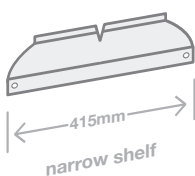

Branded header board

D3 Signage overview

PAGE 7

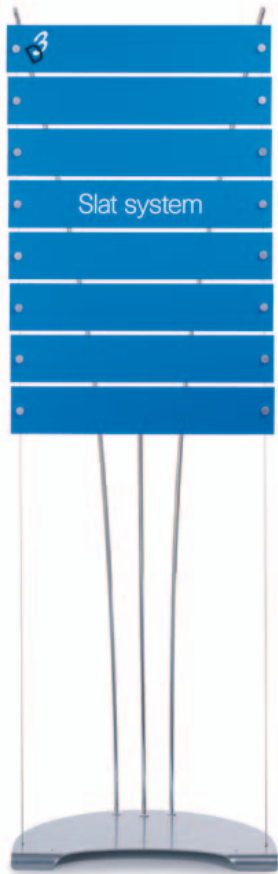

D3 Signage display

Height 180cm
Width 54cm
Depth 35cm
Weight 7kg

Freestanding, easy to change slat signage units can be created using D3 frames. Header boards or sign panels made from lightweight rigid aluminium, foamex or acrylic. Text and images can be applied using either cut vinyl lettering or full colour printed graphics.

D3 Displays can be either 1.65m high or 1.8m high. Standard 10cm x 41.5cm and 54cm width aluminium slats are available from stock. Custom sizes in a variety of materials can be made to order.

Signage displays can also be combined with poster holders, leaflet dispensers and product shelves.

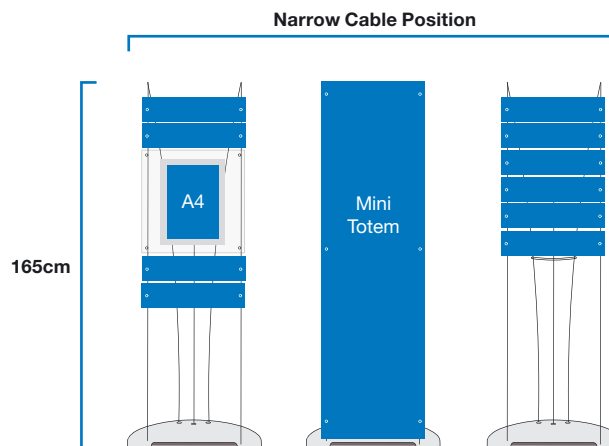

Accessories:

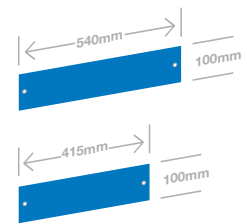

Full colour graphics



Cut vinyl lettering

